

Guardzman®

Galvanized
Ornamental
Steel Fence
Solutions



FENCE SOLUTIONS IN ORNAMENTAL • CHAIN LINK • WOOD • PVC • ACCESS CONTROL

WWW.MERCHANTSMETALS.COM 866-888-5611

 Merchants Metals®
the first name in fence solutions

Guardsman combines the traditional style and flexibility of riveted construction with modern technology to provide long-lasting beauty and security in a high-quality ornamental steel fence system.

Every Guardsman section is factory assembled by highly trained craftsmen. The process begins



with pre-galvanized steel, which creates a powerful layer of protective coating. The pickets and rails are then connected with high-quality aluminum rivets, giving the fence

additional strength and the flexibility to move up and down along the terrain.

Merchants Metals' state-of-the-art powder coating line produces a superior coating and the finish carries a 15 year limited warranty.



Its classic design, high quality construction and variety of heights and styles make Guardsman the architect's choice in ornamental steel fencing.



STAFFORD 3 RAIL FENCE STYLE WITH RINGS

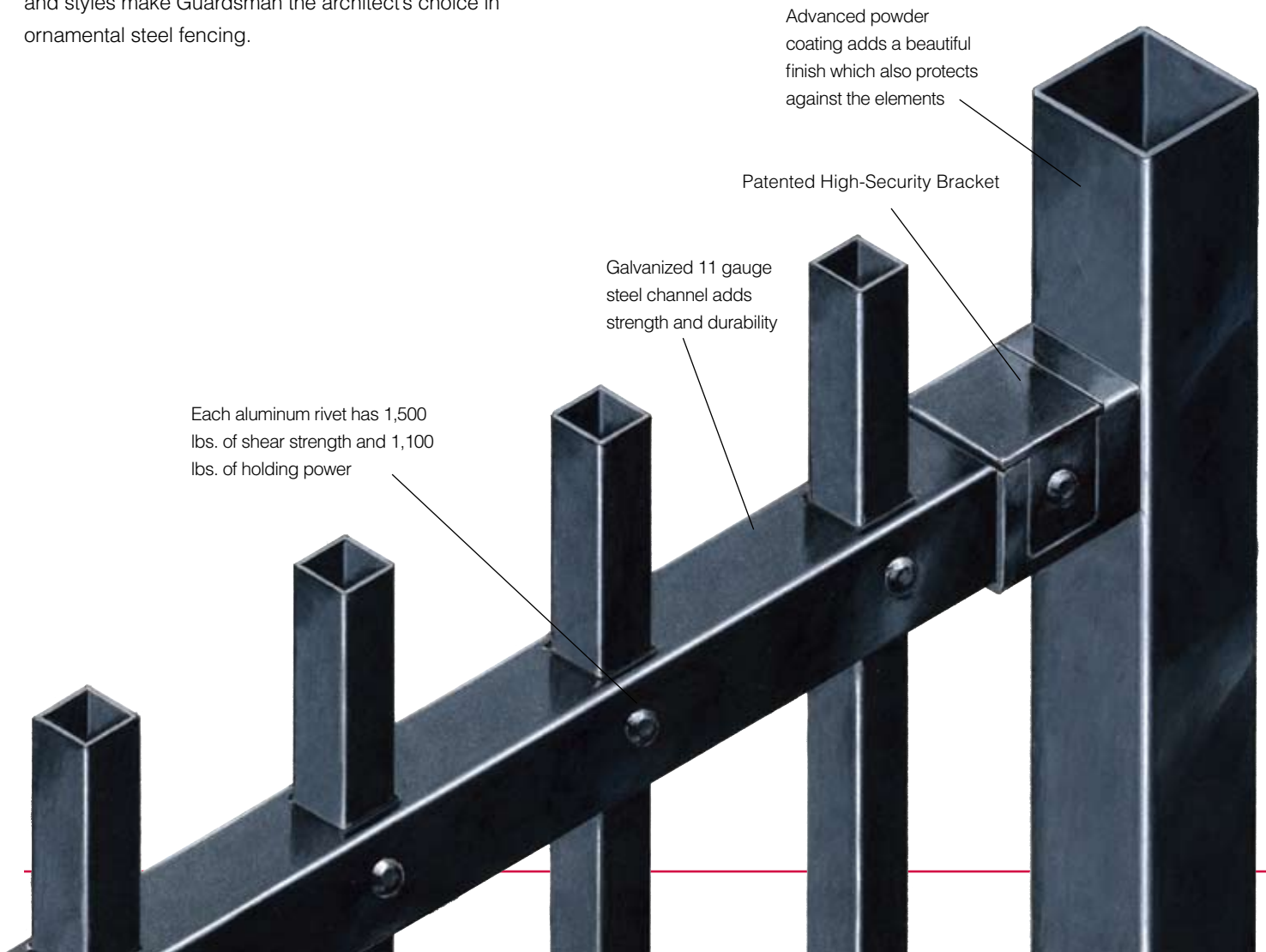

Advanced powder coating adds a beautiful finish which also protects against the elements

Patented High-Security Bracket

Galvanized 11 gauge steel channel adds strength and durability

Each aluminum rivet has 1,500 lbs. of shear strength and 1,100 lbs. of holding power



STAFFORD 3 RAIL FENCE STYLE WITH RINGS



LAFAYETTE 3 RAIL FENCE STYLE WITH RINGS



KENT 3 RAIL FENCE STYLE WITH SECURE-TRAC GATE

FEATURES

Galvanized Steel

Powder Coated

Fifteen Year Limited Warranty

Variety of Heights and Styles

**Commercial and
Industrial Applications**

Advanced powder coating process

Merchants Metals leads the industry with an advanced powder coating process that incorporates a five-stage cleaning process for an added boost in protection power. This removes any impurities that could potentially mar the finish. Combined with a corrosion-resistant epoxy powder primer and polyester powder top coat, this ensures that each Guardsman fencing system will be

highly resistant to the effects of the outdoor elements.

All Guardsman Fence Systems are assembled and riveted at the Merchants Metals factory to minimize your installation time and ensure long-term structural integrity. After powder coating, the fence panels and posts are shipped in carefully packaged pallets for economical and damage-free transit.



Merchants Metals Maintenance Free Powder Coated Finish

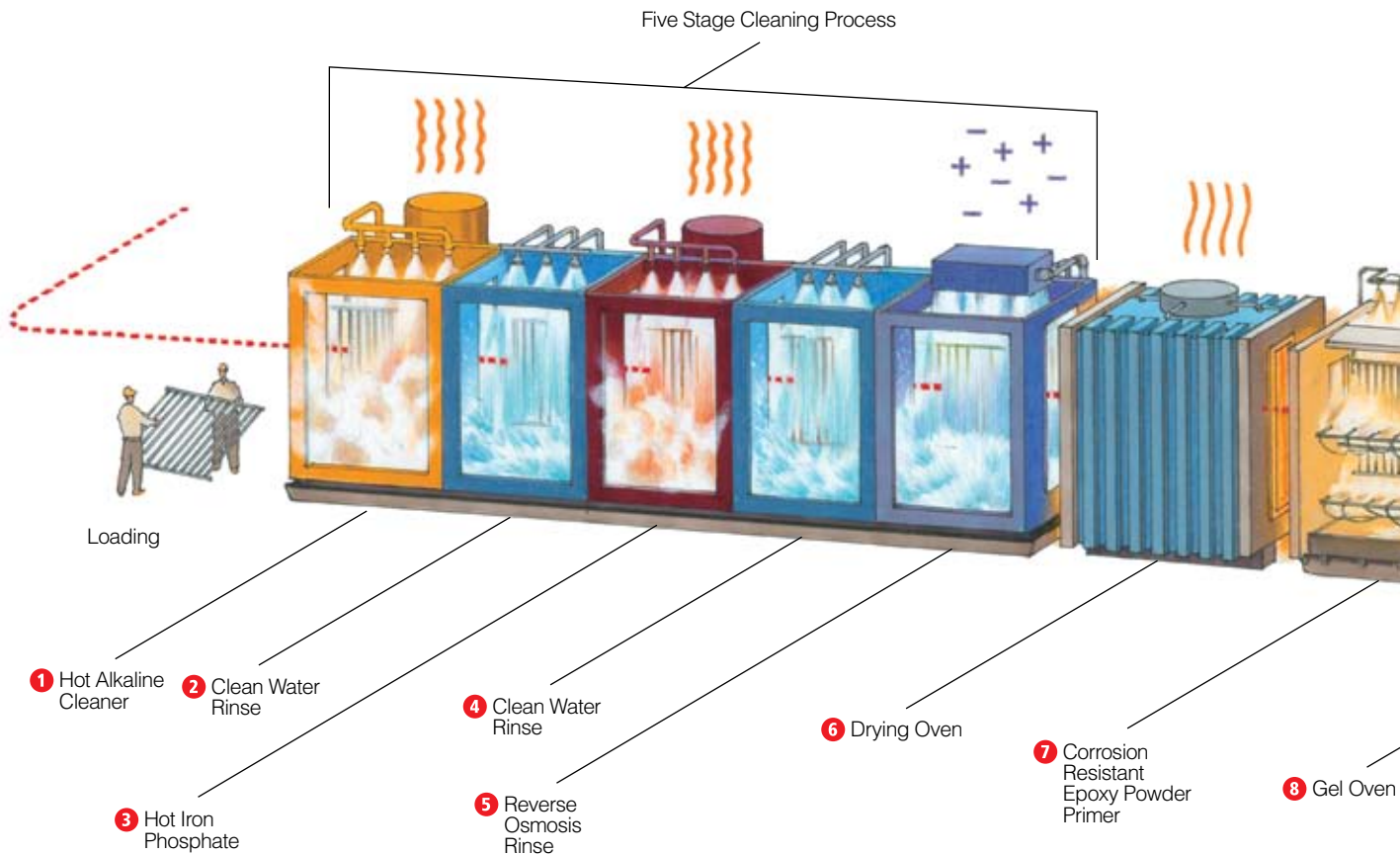
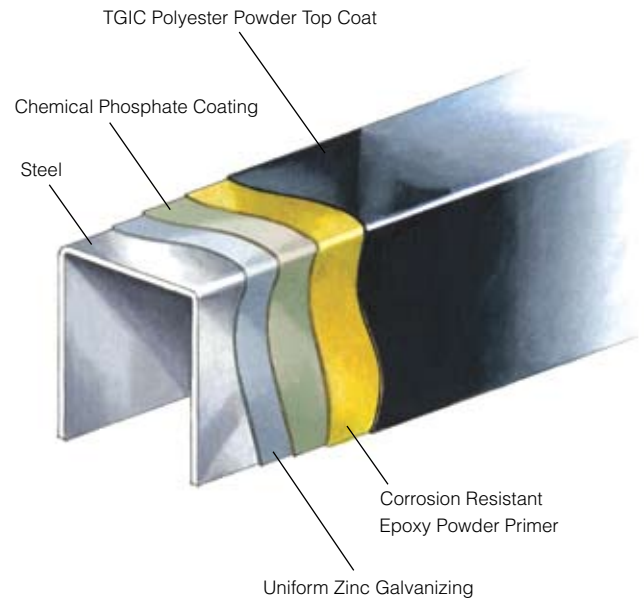

Monroe

Two Rail



Lafayette

Two Rail



Kent

Two Rail

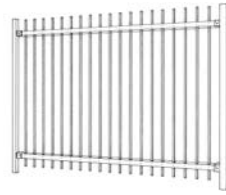

Stafford

Two Rail

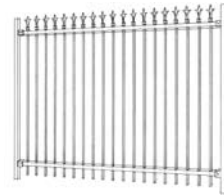

Security Guard

Two Rail



Three Rail



Three Rail



Three Rail

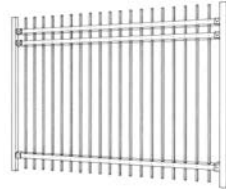

Three Rail



Three Rail



Four Rail



Four Rail

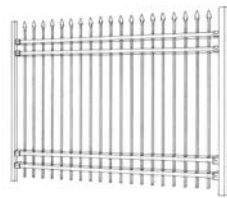

Four Rail

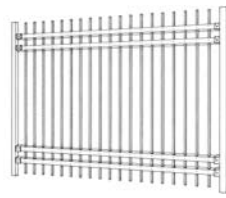

Four Rail

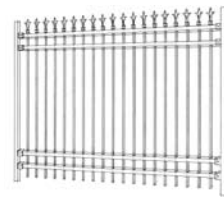

Four Rail



A clean and simple design, with no pickets above the top rail.

A straight and elegant design with pressed point pickets.

A classic design with square top pickets.

A simple yet elegant design with finial-style tops.

A high security design which creates an imposing presence with a sense of style.

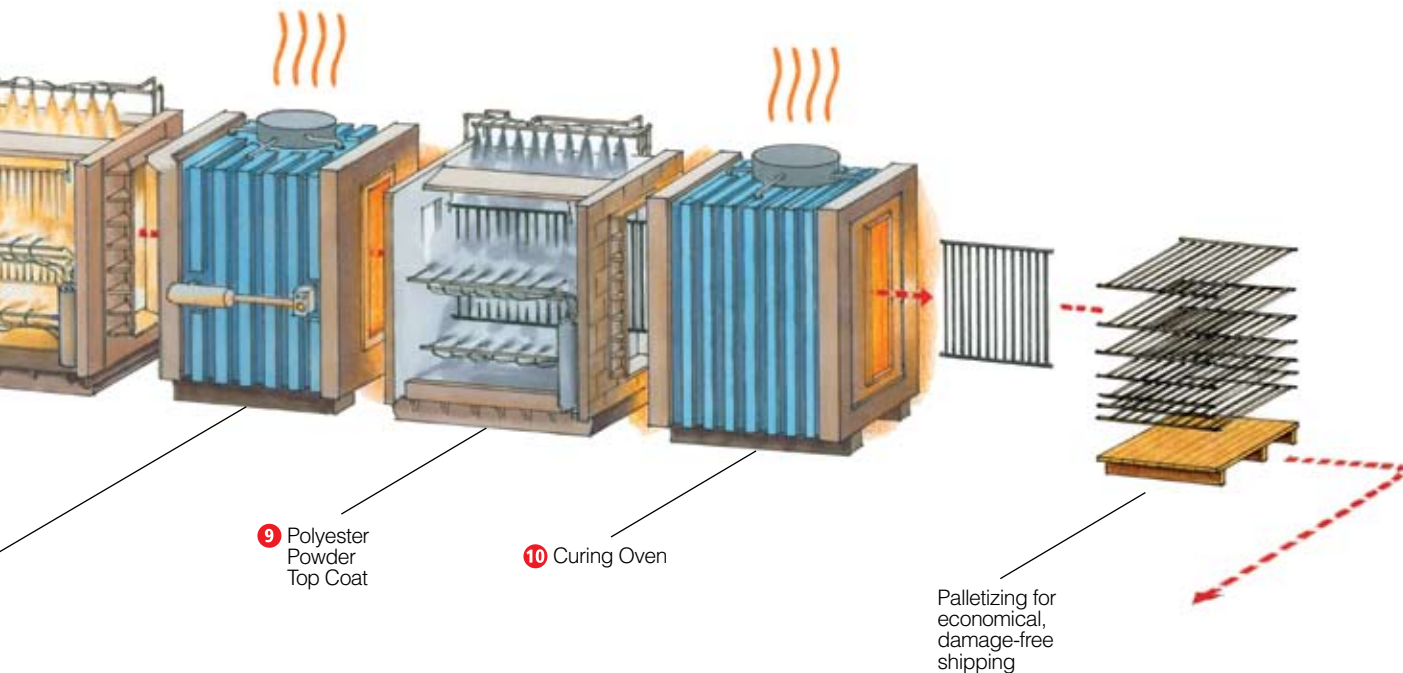

Gates

A large selection of gates, posts and accessories are available to coordinate with your Guardsman fencing solution. All are intricately fashioned by skilled craftsmen and then completed at the Merchants Metals factory with the same high-quality powder coat finishing.

These beautiful and durable ornamental accessories help to provide a formidable defense against intrusion and add architectural interest to your residential, commercial or industrial property.



MONROE THREE RAIL WITH RINGS AND SINGLE SWING GATE



MONROE FENCE STYLE GATE WITH RINGS

Secure-Trac® Cantilever Gate

Secure-Trac internal roller cantilever slide gates are produced using the highest quality materials and workmanship. The fully enclosed rollers eliminate safety issues commonly associated with external rollers and the gates are available to match each style of Guardsman fence.



SECURE-TRAC CANTILEVER SLIDE GATE

Single Gates

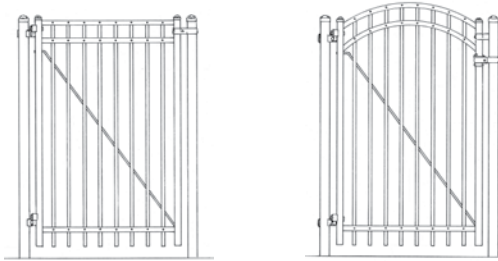

Double Gates

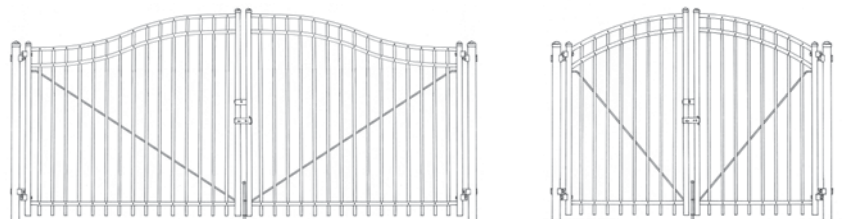
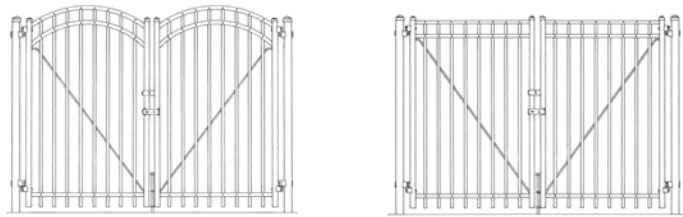

For ten foot openings and larger

SPECIFICATIONS

	Guardsman Commercial	Guardsman Industrial
Picket Size	¾ inch square 18 and 16 gauge	1 inch square 18, 16 and 14 gauge
Rail Size	1 ½ inch X 1 ⅝ inch X 11 gauge U-Channel	1 ½ inch X 1 ⅝ inch X 11 gauge U-Channel
Panel Length	90 ¼ inch	90 ¼ inch
Number of Pickets	19	18

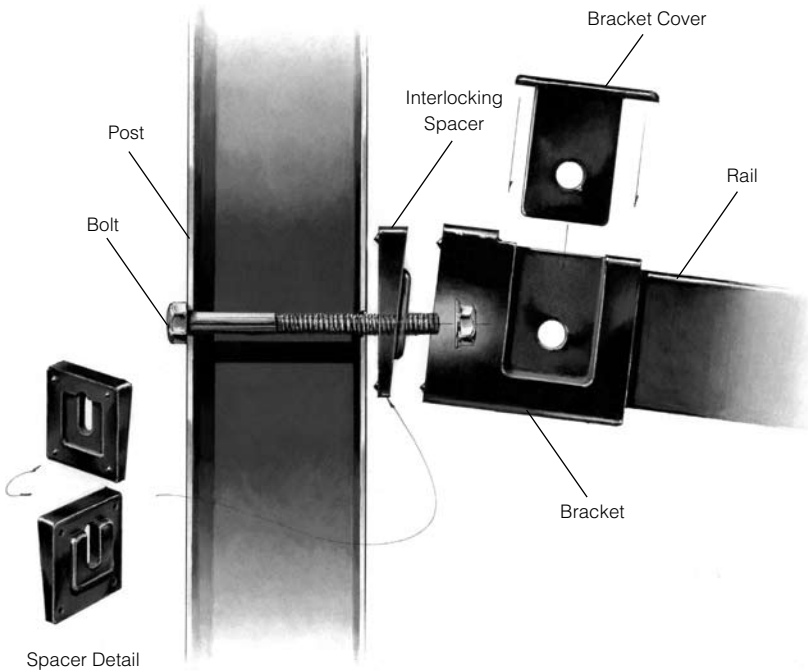

Versatile Swivel Bracket

The Guardsman's swivel bracket can increase the fence's racking capabilities and make it easy to follow the course of a landscape. Each spacer changes the angle by 7½ degrees and adds ⅜ inch distance between posts. The bracket's tamper-proof construction also adds to the fence's security.

Guardsman fencing and gates are available with or without decorative rings.

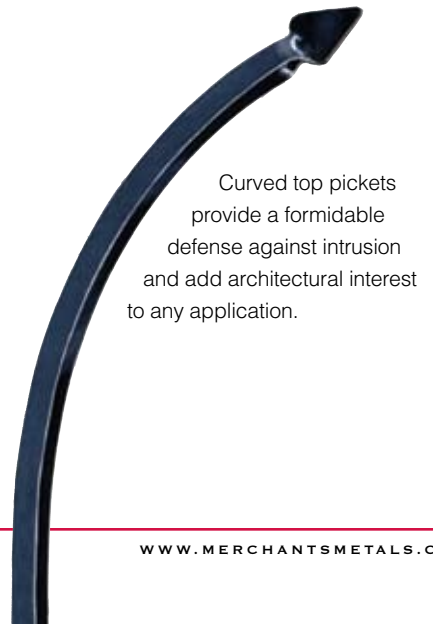
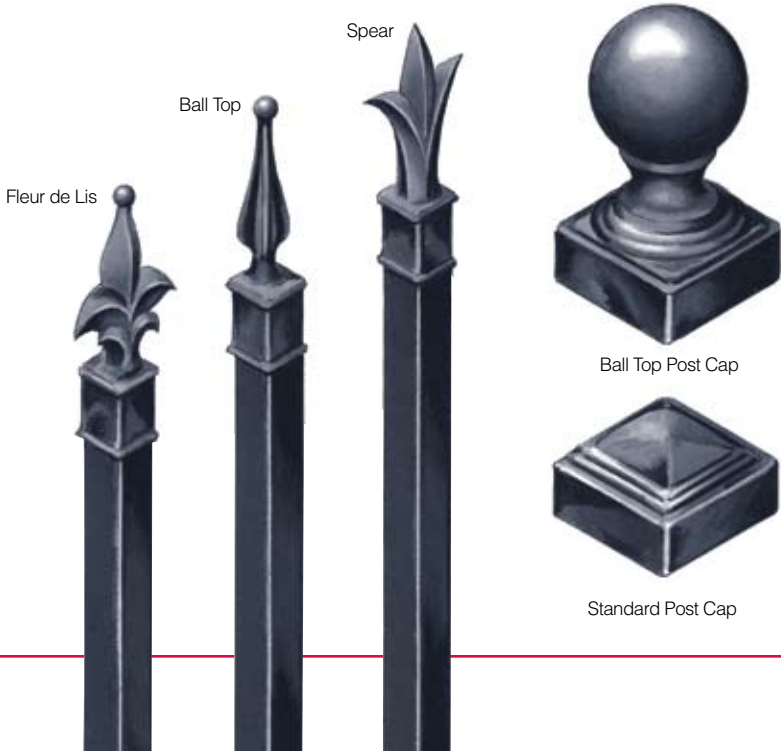

Curved top pickets provide a formidable defense against intrusion and add architectural interest to any application.

Additional Fence Solutions

Merchants Metals is one of the largest manufacturers and distributors of fence systems in the nation. The company's complete line of fencing solutions for residential, commercial and industrial applications includes:

- Hot Dipped Galvanized Chain Link
- Color Coated Chain Link
- Steel Ornamental in Both Component and Fully-Welded Systems
- Aluminum Ornamental Systems
- Wood Fence
- PVC Fence, Rail and Deck
- Temporary Fence
- Aluminum Track Gates
- Access Control Products
- K-8 Rated Cable System
- Guardrail

All Merchants Metals products are available through our Authorized Dealer network and other professional fence contractors.

To find out more about Merchants Metals and the fencing solutions we offer, please call 866.888.5611 or visit www.merchantsmetals.com.

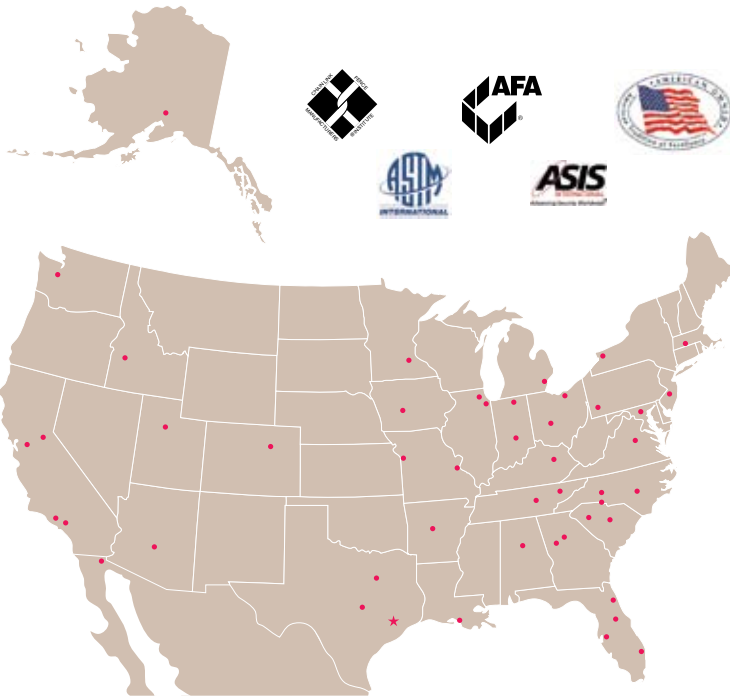

ORNAMENTAL



CHAIN LINK



WOOD



PVC



ACCESS CONTROL



3838 N. Sam Houston Pkwy. E., Suite 600
 Houston, Texas 77032
 281.372.3800 866.888.5611 fax 281.372.3801
www.merchantsmetals.com
 a division of MMI Products, Inc.